

N 50 Ω

Attenuator
Plug/Jack

53AS102-K30N3

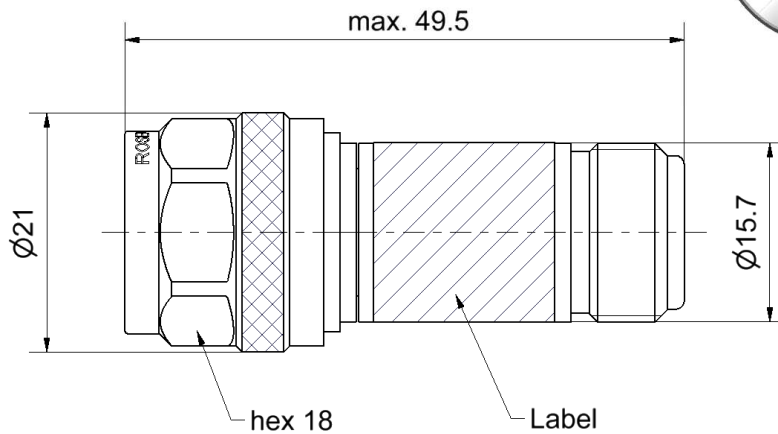

All dimensions are in mm; tolerances according to ISO 2768 m-H

Interface

According to IEC 61169-16

Documents

N/A

Material and plating

Connector parts

- Center contact - plug
- Center contact - jack
- Outer contact
- Coupling nut
- Dielectric
- Substrate

Material

- Brass
- CuBe
- Brass
- Brass
- PTFE
- Al₂O₃

Plating

- Gold, min. 1.27 µm, over nickel
- Gold, min. 1.27 µm, over nickel
- Flash white bronze over silver(e.g. Optargen®)
- Flash white bronze over silver(e.g. Optargen®)

Dieses Dokument ist urheberrechtlich geschützt • This document is protected by copyright • Rosenberger Hochfrequenztechnik GmbH & Co. KG

RF_35/09;14/6.2

N 50 Ω

Attenuator
Plug/Jack

53AS102-K30N3

Electrical data

Impedance 50 Ω
 Frequency DC to 12.4 GHz
 Return loss ≥ 26.4 dB, DC to 4 GHz
 ≥ 20.8 dB, 4 GHz to 10 GHz
 ≥ 19.1 dB, 10 to 12.4 GHz
 Attenuation 30 dB ± 0.3 dB, DC to 4 GHz
 30 dB ± 0.6 dB, 4 GHz to 8 GHz
 30 dB ± 1.0 dB, 8 GHz to 12.4 GHz
 Power handling 2 W at 25°C
 derated linearity to 0 Watts at 125°C

Mechanical data

Mating cycles ≥ 500
 Coupling nut retention ≥ 450 N
 Center contact captivation ≥ 28 N
 Maximum torque 1.70 Nm
 Recommended torque 0.70 Nm to 1.10 Nm

Environmental data

Operating temperature range¹ 0 °C to +50 °C
 Storage temperature range -40 °C to +85 °C
 RoHS compliant

¹ Temperature range over which these specifications are valid.

Packing

Standard 1 pce in bag
 Weight 67.0 g/pce

While the information has been carefully compiled to the best of our knowledge, nothing is intended as representation or warranty on our part and no statement herein shall be construed as recommendation to infringe existing patents. In the effort to improve our products, we reserve the right to make changes judged to be necessary.

Draft	Date	Approved	Date	Rev.	Engineering change number	Name	Date
Kerstin Herzog	06.01.05	Lars Ramtke	05.02.16	b00	16-0025	Marion Striegler	05.02.16

Rosenberger Hochfrequenztechnik GmbH & Co. KG P.O.Box 1260 D-84526 Tittmoning Germany www.rosenberger.de				Tel. : +49 8684 18-0 Email : info@rosenberger.de			Page 2 / 2
--	--	--	--	---	--	--	---------------