

**Superbright Red GMA8275C
Superbright Red GMC8275C**

PACKAGE DIMENSIONS

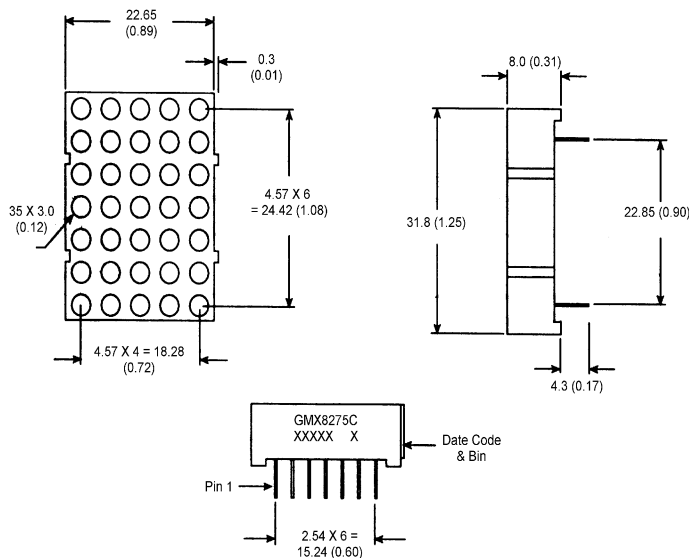

DESCRIPTION

The GMX8275C is a 5 X 7, Superbright red dot matrix display. Populated with GaAIAs/GaAs Single Hetero Junction LEDs, it has a grey face with white segment color.

FEATURES

- 1.2" (30.5mm) character height.
- Low power requirement.
- Wide 130 degree viewing angle.
- High brightness and contrast
- 5 X 7 array with X-Y select.
- X-Y stackable.
- Easy mounting on P.C. board.

NOTE: Dimensions are in mm (inch).
Tolerances are ± 0.25 (0.1) unless otherwise noted.
All pins are 0.5 (.02).

MODEL NUMBERS

<u>Part Number</u>	<u>Colour</u>	<u>Description</u>
GMA8275C	AlGaAs Red	Common anode row.
GMC8275C	AlGaAs Red	Common cathode row.

(For other color options, contact your local area Sales Office)

ABSOLUTE MAXIMUM RATING ($T_A = 25^\circ\text{C}$ unless otherwise specified)

	Superbright Red	Units
Peak forward current per segment (Duty cycle 1/10, 10KHz)	200	mA
Continuous IF per segment	30	mA
Power dissipation per segment	100*	mW
*Derate linearly from 25°C	0.5	mW/°C
Reverse voltage VR per segment	5	Volts
Operating and storage temperature range.....	-25°C to +85°C	
Soldering time at 260°C..... (1/16" below seating plane)	3 sec	

ELECTRO - OPTICAL CHARACTERISTICS ($T_A = 25^\circ\text{C}$ unless otherwise specified)

	Superbright Red	Test Condition
Luminous Intensity/Dot Digit average (Typical)	5000ucd	$I_F = 20\text{mA}$
Forward voltage (V_F) typical	1.8V	$I_F = 20\text{ mA}$
maximum	2.5V	$I_F = 20\text{ mA}$
Peak wavelength (nm)	660nm	$I_F = 20\text{ mA}$
Spectral line half width (nm)	20nm	$I_F = 20\text{mA}$
Reverse breakdown voltage V_R	5V	$I_R = 100\text{uA}$

PIN CONNECTION:

GMA8275C

Pin Number	Function	Pin Number	Function
1	Anode Row 5	8	Anode Row 3
2	Anode Row 7	9	Anode Row 1
3	Cathode Column 2	10	Cathode Column 4
4	Cathode Column 3	11	Cathode Column 3
5	Anode Row 4	12	Anode Row 4
6	Cathode Column 5	13	Cathode Column 1
7	Anode Row 6	14	Anode Row 2

GMC8275C

Pin Number	Function	Pin Number	Function
1	Cathode Row 5	8	Cathode Row 3
2	Cathode Row 7	9	Cathode Row 1
3	Anode Column 2	10	Anode Column 4
4	Anode Column 3	11	Anode Column 3
5	Cathode Row 1	12	Cathode Row 4
6	Anode Column 5	13	Anode Column 1
7	Cathode Row 6	14	Cathode Row 2

SCHEMATIC:

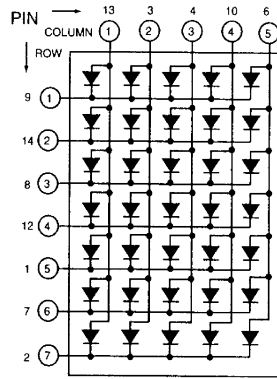

GMC8X75C

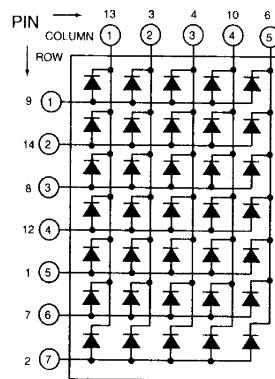

GMA8X75C

GRAPHICAL DETAIL: AlGaAs Red ($T_A = 25^\circ\text{C}$ unless otherwise specified)

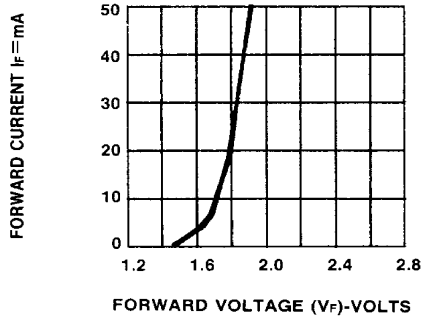

Fig.1 FORWARD CURRENT VS. FORWARD VOLTAGE.

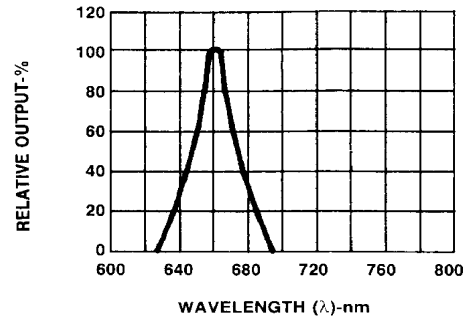

Fig.2 SPECTRAL RESPONSE

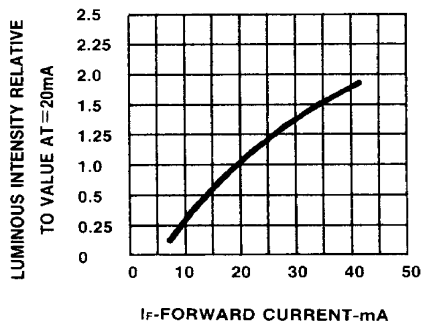

Fig.3 RELATIVE LUMINOUS INTENSITY VS. FORWARD CURRENT

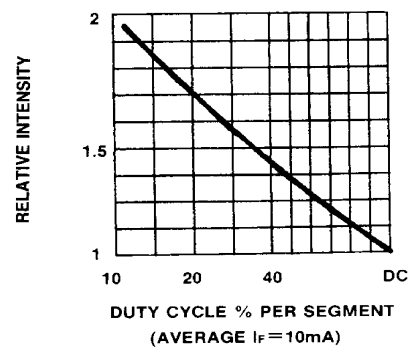

Fig.5 LUMINOUS INTENSITY VS. DUTY CYCLE

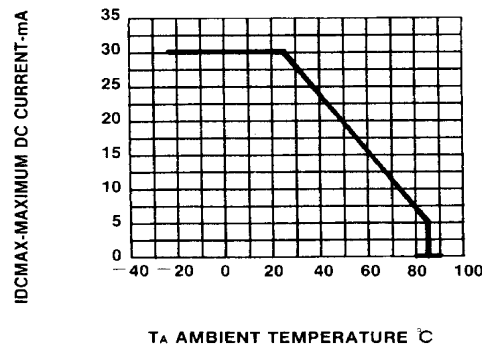

Fig.4 MAXIMUM ALLOWABLE DC CURRENT PER SEGMENT VS. A FUNCTION OF AMBIENT TEMPERATURE.

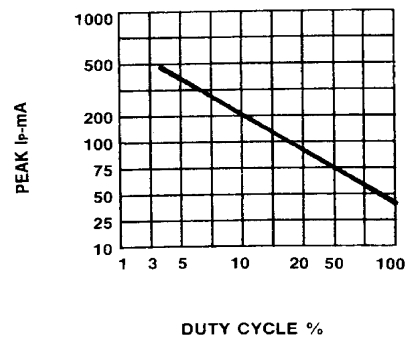

Fig. 6 MAX PEAK CURRENT VS. DUTY CYCLE % (REFRESH RATE $f = 1 \text{ KHz}$)

DISCLAIMER

FAIRCHILD SEMICONDUCTOR RESERVES THE RIGHT TO MAKE CHANGES WITHOUT FURTHER NOTICE TO ANY PRODUCTS HEREIN TO IMPROVE RELIABILITY, FUNCTION OR DESIGN. FAIRCHILD DOES NOT ASSUME ANY LIABILITY ARISING OUT OF THE APPLICATION OR USE OF ANY PRODUCT OR CIRCUIT DESCRIBED HEREIN; NEITHER DOES IT CONVEY ANY LICENSE UNDER ITS PATENT RIGHTS, NOR THE RIGHTS OF OTHERS.

LIFE SUPPORT POLICY

FAIRCHILD'S PRODUCTS ARE NOT AUTHORIZED FOR USE AS CRITICAL COMPONENTS IN LIFE SUPPORT DEVICES OR SYSTEMS WITHOUT THE EXPRESS WRITTEN APPROVAL OF THE PRESIDENT OF FAIRCHILD SEMICONDUCTOR CORPORATION. As used herein:

1. Life support devices or systems are devices or systems which, (a) are intended for surgical implant into the body, or (b) support or sustain life, and (c) whose failure to perform when properly used in accordance with instructions for use provided in the labeling, can be reasonably expected to result in a significant injury of the user.
2. A critical component in any component of a life support device or system whose failure to perform can be reasonably expected to cause the failure of the life support device or system, or to affect its safety or effectiveness.