



Honeywell Sensing and

MLH010BSG17B

Teilenummer:	MLH010BSG17B
Hersteller / Marke:	Honeywell Sensing and Productivity Solutions
Produktbeschreibung	TRANS MLH010 BAR S 43650-C G1
Datenblätter:	1.MLH010BSG17B.pdf 2.MLH010BSG17B.pdf
RoHS Status	 Bleifrei / RoHS-konform
Liefern von	Hongkong
Versandweg	DHL/Fedex/TNT/UPS/EMS

[ANGEBOTSANFRAGE](#)

Productivity Solutions



Bild kann Darstellung sein. Siehe Spezifikationen für Produktdetails.





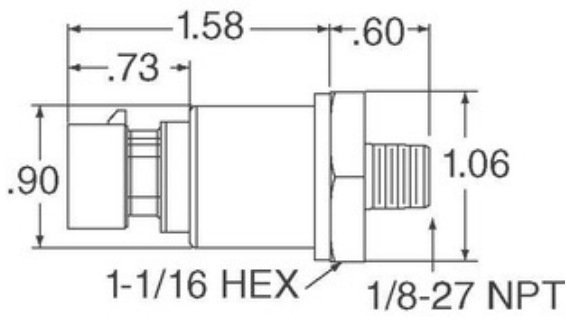

Spezifikationen von MLH010BSG17B

TEILENUMMER	MLH010BSG17B
HERSTELLER	Honeywell Sensing and Productivity Solutions
BESCHREIBUNG	TRANS MLH010 BAR S 43650-C G1
BLEIFREIER STATUS / ROHS STATUS	Bleifrei / RoHS-konform
DATENBLATT	1.MLH010BSG17B.pdf 2.MLH010BSG17B.pdf
SPANNUNGSVERSORGUNG	9.5 V ~ 30 V
SUPPLIER DEVICE-GEHÄUSE	-
SERIE	MLH
DRUCK-ART	Sealed Gauge
PORT-STIL	Threaded
ANSCHLUSSGRÖSSE	Male - 1/4" (6.35mm) BSP
VERPACKUNG / GEHÄUSE	Cylinder, Metal
AUSGABETYP	Analog Current
AUSGABE	4 mA ~ 20 mA
BETRIEBSTEMPERATUR	-40°C ~ 125°C
BETRIEBSDRUCK	145.04 PSI (1000 kPa)
FEUCHTIGKEITSEMPFINDLICHKEITSNIVEAU (MSL)	1 (Unlimited)
MAXIMALER DRUCK	435.11 PSI (3000 kPa)
HERSTELLER STANDARD VORLAUFZEIT	10 Weeks
BLEIFREIER STATUS / ROHS-STATUS	Lead free / RoHS Compliant
EIGENSCHAFTEN	Amplified Output, Temperature Compensated
DETAILLIERTE BESCHREIBUNG	Pressure Sensor 145.04 PSI (1000 kPa) Sealed Gauge Male - 1/4" (6.35mm) BSP 4 mA ~ 20 mA Cylinder, Metal
GENAUIGKEIT	±0.25%

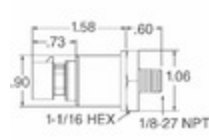
Verwandte Tags

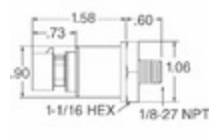
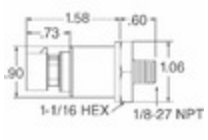
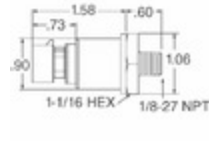
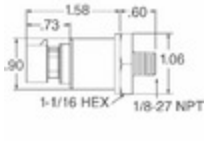
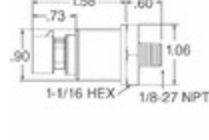
Honeywell Sensing and Productivity Solutions MLH010BSG17B	MLH010BSG17B-Verteiler	MLH010BSG17B Lieferant
MLH010BSG17B Preis	MLH010BSG17B Bilder	MLH010BSG17B-Bild
MLH010BSG17B PDF-Datenblatt	MLH010BSG17B Datenblatt herunterladen	MLH010BSG17B-Datenblatt
MLH010BSG17B Aktie	Kaufen Sie MLH010BSG17B	Kaufen Sie Honeywell Sensing and Productivity Solutions MLH010BSG17B
Honeywell Sensing and Productivity Solutions MLH010BSG17B	Honeywell Sensing and Productivity Solutions Lieferant	Honeywell Sensing and Productivity Solutions-Verteiler
Honeywell Sensing and Productivity Solutions MLH010BSG17B	HONEYWELL MLH010BSG17B	Honeywell Sensing and Control EMEA MLH010BSG17B
Honeywell Sensing and Productivity Solutions T&M MLH010BSG17B		

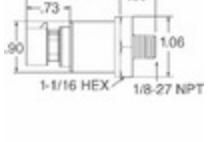
Verwandte Produkte

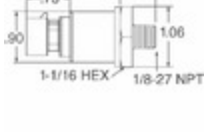
 <p>MLH010BSH08A Hersteller: Honeywell Sensing and Productivity Solutions Beschreibung: SENSOR SEALED GAUGE 0-10 BAR Auf Lager: Out stock</p> <p>RFQ</p>	 <p>MLH010BSL01A Hersteller: Honeywell Sensing and Productivity Solutions Beschreibung: MLH ALL METAL PRESS SENSE -ATF Auf Lager: Out stock</p> <p>RFQ</p>
 <p>MLH010BST14A Hersteller: Honeywell Sensing and Productivity Solutions Beschreibung: MLH ALL METAL PRESS SENSE -ATF Auf Lager: Out stock</p> <p>RFQ</p>	 <p>MLH010BSL06B Hersteller: Honeywell Sensing and Productivity Solutions Beschreibung: SENSOR SEALED GAUGE 0-10 BAR Auf Lager: Out stock</p> <p>RFQ</p>
 <p>MLH010BSB06E Hersteller: Honeywell Sensing and Productivity Solutions Beschreibung: SENSOR GAUGE 0-10 BAR Auf Lager: Out stock</p> <p>RFQ</p>	 <p>MLH010KSC14G Hersteller: Honeywell Sensing and Productivity Solutions Beschreibung: MLH ALL METAL PRESS SENSE Auf Lager: Out stock</p> <p>RFQ</p>
 <p>MLH010BGP01B Hersteller: Honeywell Sensing and Productivity Solutions Beschreibung: MLH ALL METAL PRESS SENSE -ATF Auf Lager: Out stock</p> <p>RFQ</p>	 <p>MLH010BGT14A Hersteller: Honeywell Sensing and Productivity Solutions Beschreibung: SENSOR GAUGE 0-10 BAR Auf Lager: Out stock</p> <p>RFQ</p>
 <p>MLH010BSB01B Hersteller: Honeywell Sensing and Productivity Solutions Beschreibung: SENSOR GAUGE 0-10 BAR Auf Lager: Out stock</p> <p>RFQ</p>	 <p>MLH010BSG01B Hersteller: Honeywell Sensing and Productivity Solutions Beschreibung: SENSOR GAUGE 0-10 BAR Auf Lager: Out stock</p> <p>RFQ</p>
 <p>MLH010BSG19B Hersteller: Honeywell Sensing and Productivity Solutions Beschreibung: TRANS MLH010 BAR S 43650-C PT1 Auf Lager: Out stock</p> <p>RFQ</p>	 <p>MLH010BSC17G Hersteller: Honeywell Sensing and Productivity Solutions Beschreibung: MLH ALL METAL PRESS SENSE -ATF Auf Lager: Out stock</p> <p>RFQ</p>